

MedRound



User guide

Copyright © 2025 by Parity Medical.

All rights reserved. No part of this publication may be reproduced, distributed, or transmitted in any form or by any means, including photocopying, recording, or other electronic or mechanical methods, without the prior written permission of Parity Medical. For permission requests, write to Parity Medical at the address below.

Parity Medical, Port Causeway, Wirral International Business Park, Bromborough, Wirral, CH62 4TP, United Kingdom

Other questions? Contact us at:

 +44 (0)151 343 0500

 enquiries@paritymedical.com

Thank you for choosing to buy a Parity Medical cart!

This cart is intended to mobilise clinical information access to bring it to the point of care, wherever and whenever that may be. It was designed for use by medical practitioners and relevant administrative support staff; it should not be used by patients or anyone who has a health condition or disability which would impede their ability to manoeuvre or operate it safely.

This user guide is for users of the cart and instructs how to safely operate the cart, explaining the basic functions, adjustments, troubleshooting, and maintenance procedures to be performed by the user. Various parts of the cart are discussed by means of text, illustrations, photographs, and standard terms.

Parity Medical is dedicated to ensuring the safety, comfort, and convenience of clinicians as well as the patients under their care. All users should familiarise themselves with the contents of this user guide before operating the cart and store this document in a location where it can be referred to whenever necessary.

As well as this user guide, users are encouraged to review and follow the advice in our Cart Maintenance & Lifecycle Guidance document, which helps to maintain optimal performance and extend the working life of the cart. The document can be provided by your Parity Medical Account Manager upon request.



Each cart undergoes a thorough quality control inspection prior to despatch, including Portable Appliance Testing (PAT). A PAT label is not applied to the cart, as customers typically install their own equipment such as PCs, scanners and peripherals after delivery. Once the cart has been fully configured, the complete solution should be re-tested by the appropriate personnel on site.

From time to time, we may need to change components, which may incur design updates as well as updates to this user guide. The latest version of this document is always accessible at <https://www.paritymedical.com/carts/medround-cart-2.html>.

Symbols

Regulatory agencies for health products require the use of symbols, often in place of textual statements, to improve the conspicuousness of required information, such as important safety information.

The symbols used in this guide and on the cart are described below. Be sure to observe the instructions indicated by each symbol to ensure the safe use of your Parity Medical cart.

Symbol	Description
	Indicates instructions to prevent a potentially hazardous situation that may result in injury or equipment damage.
	A reminder that the user should read the user guide before starting work or operating the equipment.

Revision history

Each page of the user guide provided with your cart has a revision letter on it in the document header. As the document is updated, the revision number is changed.

Version	Date	Comments
1.0	19 th April 2025	Original version
1.1	13 th November 2025	Overstretch of mains cables warning added
1.2	26 th May 2026	Lifecycle guidance and PAT test reference added, security lock full instructions reference added

Contents

- Cart structure 6
- Cart features and instructions 8
 - Rotate and adjust monitor (specification dependent) 8
 - Setting up your laptop (specification dependent) 9
 - Mounting your micro PC (specification dependent) 10
 - Manoeuvring the cart 11
 - Height adjustment 12
 - Security lock 13
 - Storage 13
 - Accessory mounts (specification dependent) 14
 - Charging the battery 14
 - Serial number location 15
 - Cleaning 15
 - Approved cart cleaning solutions 16
- Health and safety 17
 - Overstretch of mains cables 18
- Cart warranty and specifications 19
 - Cart warranty information 19
 - Cart specifications 19
 - Weight capacities 20
 - Electrical specifications 20
- SmartPower guide 22
 - Power on/off 22
 - Display and brightness 22
 - Cleaning 22
 - SmartPower battery alerts and warnings 23
- Troubleshooting 25
 - Height adjustment buttons not working 25
 - Noises from cart leg 25
 - Complete battery discharge 25
 - Low battery alarm 25

Cart structure

Single screen configuration

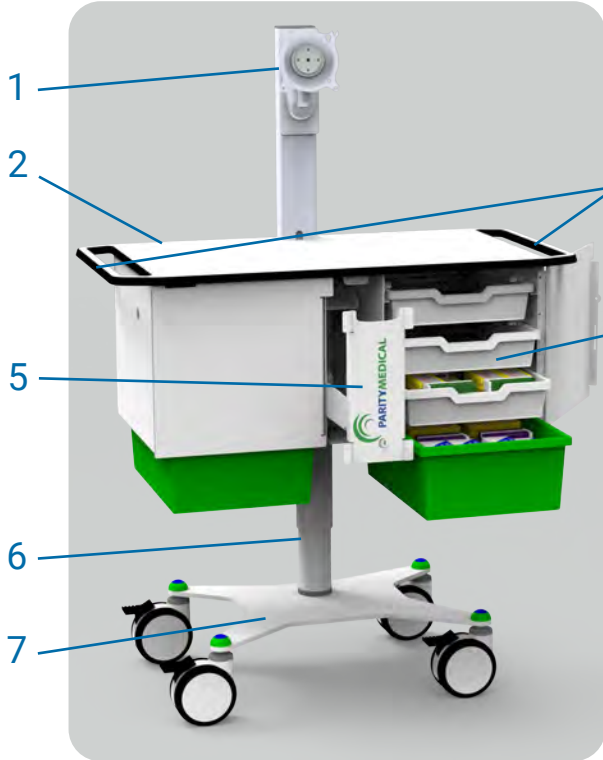

Dual screen configuration with SmartPower

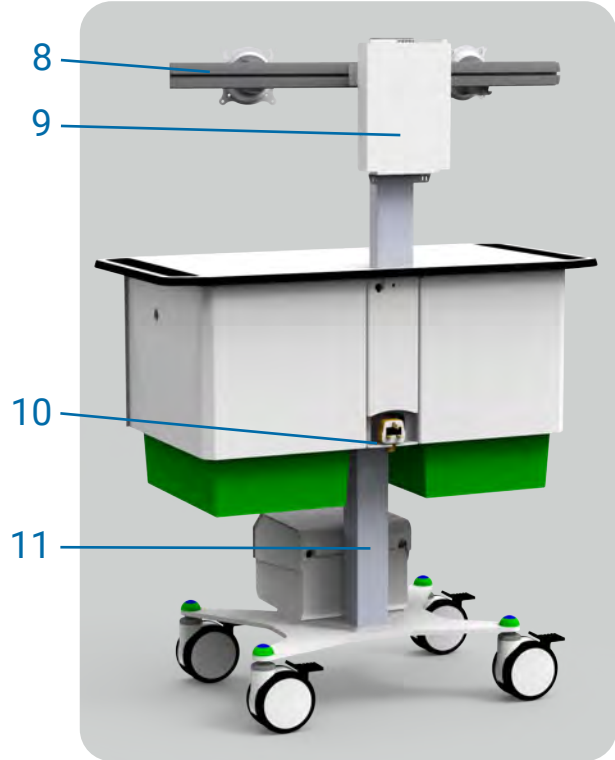

Laptop configuration with SmartPower

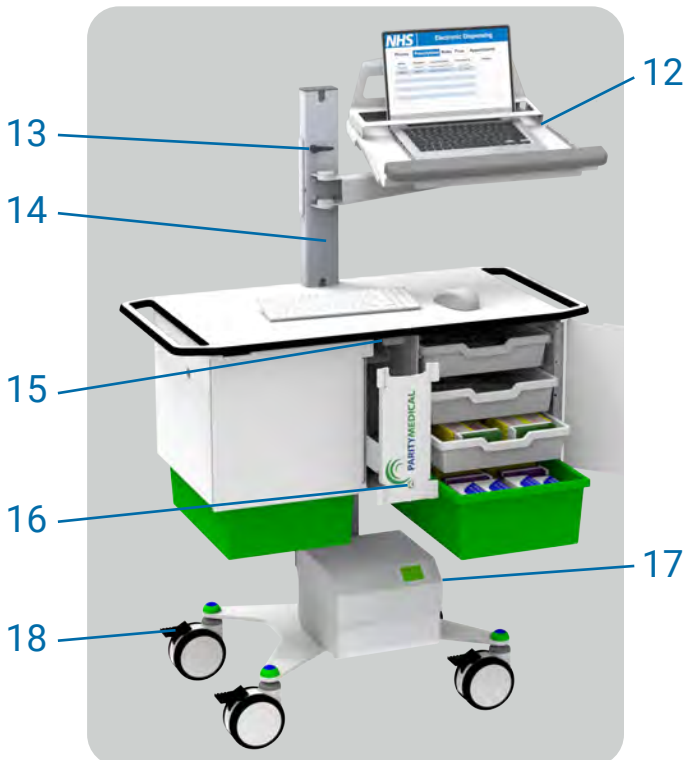

SmartPower unit display

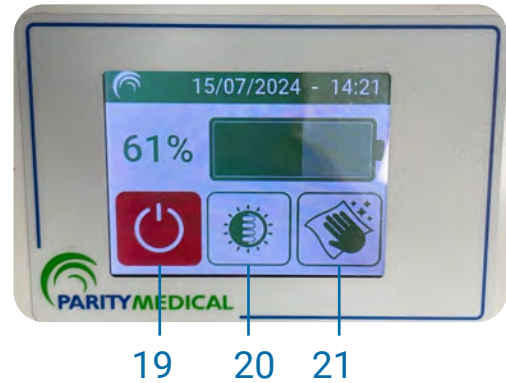

Legend:

1. VESA mount (micro PC or all-in-one PC configuration only)
2. Work surface
3. Steering handles
4. Storage drawers
5. Slide-out bottle storage
6. Manual height adjustment leg (for unpowered carts)
7. Cart base
8. Dual VESA mount
9. Micro PC enclosure
10. Charging plug and cradle (cable not shown)
11. Electric height adjustment leg (for powered carts)
12. Laptop arm and enclosure
13. Laptop arm height adjustment lever
14. Monitor/laptop arm mast
15. Height adjustment lever (unpowered carts) or height adjustment buttons (powered carts)
16. Storage lock
17. SmartPower unit (for powered carts)
18. Locking wheels
19. Power inverter button
20. SmartPower display and brightness button
21. SmartPower display cleaning button

The terms highlighted above will be shown in **bold** throughout this document to help you understand how each feature is intended to be used. The following page shows alternative configurations, with new key terms associated with the configurations shown in **bold**.

Cart features and instructions

Rotate and adjust monitor (specification dependent)

PC monitors and all-in-one PCs are mounted to the cart with a **VESA mount**. If your cart has **monitor mast** rotation and/or swivel features, you can swivel the monitor up and down, left and right, or rotate it between landscape and portrait formats. You can also raise and lower the monitor height on the mast. Simply hold the monitor firmly in both hands and adjust the position as needed.



Setting up your laptop (specification dependent)



To avoid damage and/or injury, always support the weight of the laptop arm before releasing the laptop arm's height adjustment lever (images shown below).

Laptops are mounted to the cart within the **laptop enclosure** on the **laptop arm**. If you need to open the brackets to add/remove a laptop, locate the metal nuts on each side of the laptop enclosure. Use the PM-SECNUTTOOL, which was provided with your cart, to unlock the nuts, add/remove the laptop and secure the brackets in place by tightening the nuts, as required. Different holes can be used for laptops of varying thickness. Remove the cap at the top of the **monitor mast**, and the security screw found below the mast at the rear of the cart to open the power supply caddy. Pass the power supply cables down the mast into the power supply caddy. Then, place the power supply into the caddy and plug it into the provided power connections for the cart. Re-tighten the security screw to close the caddy.

The laptop arm's height can be adjusted. Support the weight of the laptop arm with one hand before rotating the **laptop arm's height adjustment lever** counter-clockwise with your other hand to release the height adjustment lock. Once the laptop arm is set at the correct height, rotate the laptop arm's height adjustment lever clockwise until the lever is firmly locked in place. Do not overtighten the laptop arm's height adjustment lever.



Mounting your micro PC (specification dependent)



To reduce the risk of cable strain and damage when fitting a micro PC, ensure that cables are threaded out from the corners of the micro PC enclosure, and be aware of cables catching on the top of the mast whilst the micro PC enclosure is being slid into position.

Your micro PC mount can typically be found at the rear of the **monitor mast**. If you need to open the brackets to add/remove a micro PC, first remove the cap at the top of the monitor mast. Pass the power supply cables down the mast and into the power supply tray below the rear of the **work surface**. Place the power supply into the caddy, and plug it into the provided power connections for the cart. Re-tighten the security screw to close the caddy.

Loosen the security screws found below the **micro PC mount**, and slide the enclosure upwards and off the mast. Your micro PC can now be fitted to the micro PC mount, which may have standoffs on each side to hold the micro PC and reduce the risk of cable strain. Insert the relevant cables into your micro PC before reinserting the enclosure into the mast, tightening the security screws, and reattaching the monitor mast cap.



Manoeuvring the cart



Unplug the cart before moving! There is a risk of injury if the cart is moved when the cart is plugged in at the wall for charging.



For safety, the cart should always be lowered to its lowest position when being moved between hospital areas (e.g., when moving over door thresholds or travelling between floors in a lift).

If you have a screen mounted to the monitor mast, ensure that the screen is centred (not rotated to the side) and lowered to its lowest position to avoid accidental damage during transit.

Use a **steering handle** to push the cart to a new location—you will need to use both hands to move/steer it. Do not pull the cart behind or to the side of you.

The cart features four **locking wheels**. Once the user is happy with the position, the brakes should be applied to avoid further movement whilst the cart is in use. The brakes are activated by pressing down on the foot pedal on all wheels and they are unlocked by lifting the foot pedal.



Unlocked



Locked



Steering handle

Height adjustment



Before using the cart's height adjustment buttons or lever, ensure that no body parts, objects, furniture, or cables could prevent its ability to travel up or down. If there is any obstruction, stop pressing the button or level immediately and remove the obstruction before continuing.

If the cart features an **electric height adjustment leg**, you'll find the cart's **height adjustment buttons** under the centre of the **work surface's** edge. Simply press and hold the up/down buttons until the cart is at the desired height. If the buttons don't appear to work, check the SmartPower unit display at the base of the cart to make sure the **power inverter button** is turned on (the button will have a red background when turned on).

For carts with a **manual height adjustment leg**, use the **height adjustment lever** to the right-hand side of the work surface to raise or lower the cart. Press the lever upwards with your right hand and lift up/push down the work surface with your left hand to adjust the height.



Security lock

The medicines and supplies stored in the cart are protected by a **security lock**, which may be a traditional lock with a key, a digi-lock system or a lock with RFID security technology (dependent on specification). If your lock uses keypad security, enter your 4-digit pin and rotate the lever 90° to unlock. If your lock uses RFID security, tap your card against the screen and then rotate the lever 90° to unlock. When not in use, the cart's storage doors should be kept closed and the security lock armed.

A full user guide for your security lock which includes troubleshooting steps is available upon request.

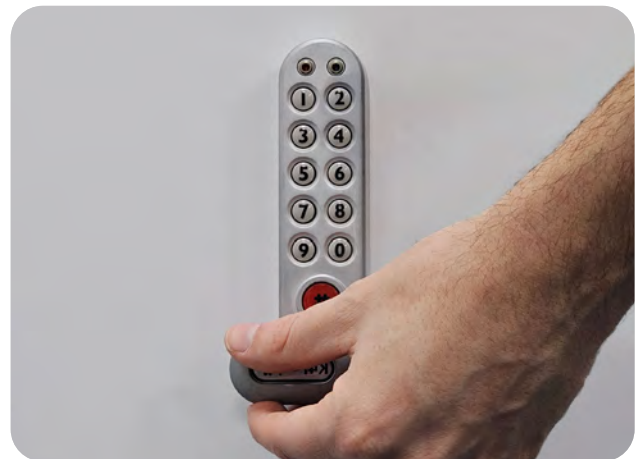

Storage

The MedRound offers up to eight **storage drawers** and a **slide-out bottle storage** area. To access them, unlock the security lock and open the doors to access the drawers, or pull out the slide-out bottle storage to access stored bottles. The doors have a magnet on them to secure the door in the fully open position to the side of the cart when in use.



Accessory mounts (specification dependent)

The cart can be fitted with barcode scanners and label printers, if required. The accessories can be fitted to the **monitor mast** or placed towards the back of the **work surface**.



Charging the battery



The cart's **battery** should be plugged in to charge when not in use to ensure a full charge when the cart is being utilised. If batteries are left for an extended period of time without charge, it will result in permanent damage to the battery. Carts should be unplugged when the battery reaches 100% to reduce unnecessary battery degradation from constant charging.

To charge a powered cart or to power devices mounted to an unpowered cart, unhook the orange **charging plug** from the **cradle**, plug it in, and switch on the power at the wall. We've installed the cart with a **breakaway cable** to avoid the risk of damage to equipment if someone accidentally moves the cart whilst it's plugged in. Once charged, stow the plug back in its cradle to reduce tripping hazards.

For a faster charge time, it is recommended that accessory devices are powered-down and the **power inverter button** is turned off while charging the battery.

- Press the power inverter button on the SmartPower unit's display to turn the power on. The button will have a red background when it is turned on.
- To turn off the power, press the power inverter button on the SmartPower unit's display, and then press the button again to confirm. The button has green background when turned off.



Serial number location

The cart's serial number label is located on the rear of the cart, on the top-right-hand side of the **storage area**.

The label contains the model name and code and the serial number. You will need this information to contact our customer support team to report an issue or check the warranty status of your cart.



Cleaning



The cart contains electrical components, so extra care should be taken to avoid getting water on the electrical systems or power cable to avoid injury or equipment damage.

Always use a damp cloth to clean your cart (not a wet cloth)—and never use a mop to clean any part of the cart, including the base.

1. Disconnect the cart from any AC outlet before cleaning.
2. Spray the cleaning solution onto a cloth—not directly onto the cart.
3. Clear the main **work surface** of any items and wipe the surface, including handles and the **monitor mast** or laptop brackets.
4. Clean the **storage area** doors and the exterior of the storage area.
5. Unlock the storage area and open the bottle drawer fully for cleaning.
6. Open the storage area doors and remove all items inside, including the drawers, and clean all surfaces. After cleaning, re-insert all drawers.
7. Clean the leg of the cart. For electric height-adjustment carts: Clean the white, top portion of the adjustable leg. Do not clean the static (silver) section of the leg. Clean the height-adjustment buttons/lever too.
8. For powered carts only (for unpowered carts, continue to the next step): Press the **SmartPower cleaning button** for 4 seconds to disable the touchscreen for 10 seconds whilst cleaning. A countdown timer will appear on screen. Clean the touchscreen area during this countdown.
9. Clean the remaining areas of the cart base, battery case, and wheels.



Approved cart cleaning solutions

- Quaternary ammonium chloride compounds (such as AirX109)
- Bleach-Household strength (1:10 minimum dilution strength)
- Ethyl or Isopropyl alcohol- 70%
- Hydrogen Peroxide
- Phenolic disinfectants (such as Lysol, WexCide)
- Ovation
- Fantastik
- Formula 409
- 1.6% Aqueous Ammonia "Green Soap" USP (United States Pharmacopoeia)
- Clinell Wipes

Health and safety



There is a risk of injury if the cart is moved whilst the cable is plugged in at the wall. Always unplug before moving.

Your cart includes a lithium-ion battery. These batteries are safe during normal use, but present risks in the following circumstances. **In the unlikely event that you smell burning or notice smoke, immediately discontinue use and follow your site's fire safety protocols.**

1. Mechanical risks

This includes anything that damages the structure of the battery, such as dropping, piercing, crushing, or exposing the battery to harsh conditions.

2. Electrical risks

This includes over-charging or short-circuiting the battery. Do not tamper with any internal circuitry, electrical systems, or wiring. Never use a wet cloth or mop to clean the battery, inverter, or LED battery status gauge casings.

3. Thermal risks

These risks occur when the battery is exposed to extremely high temperatures, such as in direct sunlight.

If any of the following situations arises, immediately discontinue use and contact your IT department.



- The power cord or plug is damaged
- Liquid has penetrated into the PC storage caddy, height-adjustment buttons, electric leg or battery case
- The equipment does not work well or if you cannot get it to work after consulting the user manual
- The cart has been dropped or damaged
- The cart has obvious signs of breakage
- Grinding noises from the cart leg

If your IT department is unable to resolve the issue, contact Parity Medical's customer support team on +44 (0)151 343 0500 (option 2) for further assistance.

Please note the following instructions for the health and safety of the user and others nearby:

- Do not lean on the cart or allow the cart to support your body weight. This can place undue stress on the height adjustment mechanism, potentially leading to damage or malfunction.
- Avoid pulling yourself up from a seated position using the cart. Using the cart as an aid to stand can exert excessive force on components not designed to bear such loads.
- Do not stand or kneel on the cart. The cart is not designed to withstand such forces, which could compromise its structural integrity and lead to potential hazards.
- Never force the cart down. If the height adjustment lever is stiff or difficult to operate, do not force it down; continuing to apply force may cause permanent damage. Discontinue using the cart and contact Parity Medical on 0151 343 0500 to report the issue and arrange for an inspection or repair.

Overstretch of mains cables



Take care not to overstretch the mains cables. This can damage the cable and cause tripping/injury hazards to nearby people.

Damaged mains cables that are a result of overstretching are one of the most frequent reasons that customers contact Parity Medical's customer services team.

To prevent overstretching the mains cable, move the cart closer to the plug socket and avoid wrapping it around other furniture.

The picture shown on the right is an example of what not to do!

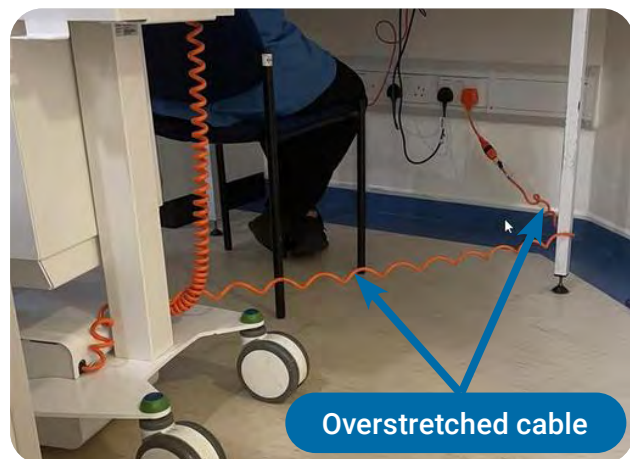

Cart warranty and specifications

Cart warranty information

Our carts come with a 5-year warranty as standard. Please note that the cart's orange power cable is covered under separate warranty, which is valid for 1 year.

Performing any repairs or modifications which are not listed in this user guide will invalidate the warranty.

Cart specifications

Height extended - unpowered	1215 mm (to top of work surface)
Height extended - powered	1218mm (to top of work surface)
Height compressed - unpowered	861 mm (to top of work surface)
Height compressed - powered	858 mm (to top of work surface)
Height adjustment difference - unpowered	354 mm
Height adjustment difference - powered	370 mm
Work surface dimensions	958 mm (w) x 478 mm (d)
Net weight (cart base only) - unpowered	54 kg
Net weight (cart base only) - powered	68 kg
Gross weight (max. load) - unpowered	69 kg
Gross weight (max. load) - powered	83 kg
Micro PC caddy internal dimensions	Specification dependent - contact Parity Medical for details

Weight capacities

Maximum weight held	Monitor mast with left/right swivel capacity	6 kg
	Monitor mast (no swivel)	8 kg or 12 kg (specification dependent)
	Square monitor mast (tilt & rotate VESA)	10 kg
	Work surface	5 kg

Electrical specifications

AC input and output power (contact Parity Medical for guidance if using outside of the UK)	Wall AC input range	100 to 250VAC, 50/60Hz
	Inverter output power (powers PC and accessories)	200W maximum

Battery	Chemistry	LiFePo4 (Lithium Iron Phosphate Battery)
	Battery nominal voltage	12.8V
	Battery nominal capacity	>= 43.2 Ah
	Battery energy	>=553 Wh
	Battery dimension	209 x 137 x 185 mm
	Operating temperature	0 to 45°C for charging -20 to 60°C for discharging
	Max battery life on an average 25W PC	19.9 hours
	Max battery life on an average 50W PC	10 hours
	Max battery life on an average 100W PC	5 hours
	Max battery life on an average 150W PC	3.3 hours
	Max battery life on an average 200W PC	2.5 hours
	Typical charging time from empty 0% to 100%	5 hours
Life expectation	>=60% of rated capacity, 1200 cycles	
Standby time	From 100% battery status with all LEDs on	Up to 17.1 days
AC cable information	Standard IEC cable with 5A fuse	

SmartPower guide

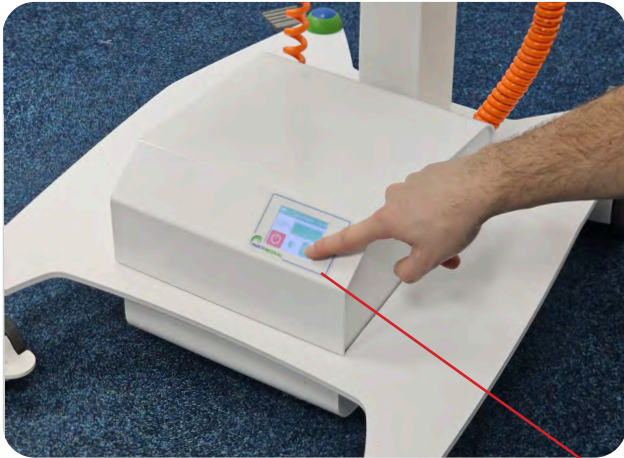

Our **SmartPower unit** uses a touch screen display. Only use light finger pressure when pressing options.

Note: the power button will display a **RED background colour** when the inverter power is switched ON.



Never spray or pour fluid directly onto the SmartPower system. Apply cleaning solution to a cleaning cloth.

Set time and date

Press and hold the top bar for 4 seconds to change the time and date.



Then, use the first arrow to select the value to change and use the up/down arrow buttons to adjust the value indicated in red.

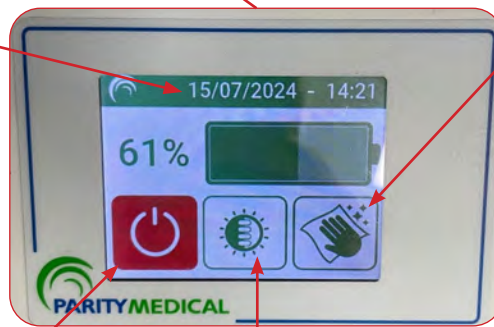

Cleaning

Press and hold the **SmartPower display cleaning button** for 4 seconds to disable touchscreen for 10 seconds for cleaning. A countdown timer will appear on screen.

Display and brightness

To turn off the backlight, press and hold the **SmartPower display and brightness button** for over 5 seconds, then release. Press and release anywhere on screen to restore the display.

To adjust screen brightness, tap (short press) the SmartPower display and brightness button to scroll through 5 different brightness settings. The different levels are indicated by small horizontal bars in the graphic below.



Power on/off





- Red background = power on
- White background = power off



To turn the inverter power off, press the red button once, then press the red button again to confirm.

Select the return option to cancel the request and leave the power on.

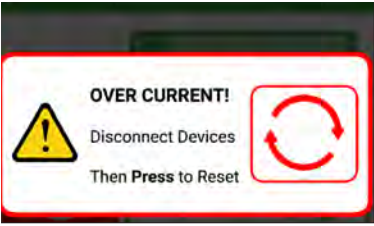

SmartPower battery alerts and warnings

	<h3>Low battery</h3>	<p>At 5%, the system will emit an audible alarm.</p> <ol style="list-style-type: none"> 1. Press the red power button to turn off the inverter. 2. Press the red power button a second time to confirm power off status. 3. Plug the cart in to charge. The home screen will now show a lightning bolt over the battery icon to indicate its charging status. 	
	<h3>Slow charge</h3>	<p>The inverter power has been left on while the SmartPower system is charging. Turn the inverter power off for faster charging.</p> <ol style="list-style-type: none"> 1. Press the red power button to turn off the inverter. 2. Press the red power button a second time to confirm power off status. 	
	<h3>⚠ Slow discharge</h3>	<p>The inverter power has been left on while the unit is charging and it is unable to recharge effectively. Reduce the power load by turning off your devices or turn the SmartPower unit off to complete the charge. If no action is taken, the system will power off.</p> <ol style="list-style-type: none"> 1. Press the red power button to turn off the inverter. 2. Press the red power button a second time to confirm power off status. 	
	<h3>⚠ Over heating</h3>	<p>The system has overheated.</p> <ol style="list-style-type: none"> 1. Check all vents around the battery casing are clear. 2. When the system has cooled, a reset screen appears—press and release the red button to reset the display back to the home screen. 	<div style="text-align: center;">  <p>These warnings are not normal operation!</p> <p>Please report any persistent warnings to Parity Medical's support team for advice.</p> </div>

	<p>⚠ Over current</p> <p>The system is powering too many high-power devices.</p> <ol style="list-style-type: none"> 1. Disconnect devices, then press the red button to reset the display back to the home screen. 	<p>⚠</p> <p>These warnings are not normal operation!</p> <p>Please report any persistent warnings to Parity Medical's support team for advice.</p>
	<p>⚠ Over voltage</p> <p>The system has been plugged into a faulty mains supply.</p> <ol style="list-style-type: none"> 1. Disconnect from the mains supply. 2. Press the red button to reset the display back to the home screen. 	

Troubleshooting

This section is provided to help you troubleshoot issues quickly onsite. If the issue you're experiencing persists or the problem isn't covered here—or if you're unsure about anything—please contact us directly on 0151 343 0500 or raise a support ticket with our customer support team at <https://www.paritymedical.com/customer-services>.

Height adjustment buttons not working

If the height adjustment buttons don't appear to be working, check that the SmartPower unit doesn't need to be charged and the power inverter button is turned on (the button will have a red background when turned on). In most cases, this will resolve the issue.

If charging the battery and turning on the power inverter button doesn't fix the issue, you will need to reset the cart leg.

To do this, follow these steps:

1. Press and hold both buttons at the same time. You'll hear an audible beep and the cart will start to be lowered.
2. Keep both buttons pressed as the cart descends. Once it has reached the lowest position, the cart will beep again.
3. The cart leg has now been reset and the height adjustment buttons should now work correctly.



Noises from cart leg

If your cart is making an unusual sound whilst being raised or lowered, please contact Parity Medical on 0151 343 0500 for further assistance.

Complete battery discharge

If the battery power is allowed to drop to 0%, the height adjustment button rest procedure outlined above will need to be followed, as the cart's leg will have lost its 'home' position.

Low battery alarm

If the battery has less than 5% power remaining, a continuous beeping alarm will be heard. To stop the alarm and fix the problem, charge the cart battery.

MedRound



Thank you for choosing to use a Parity Medical solution.
If you have any further questions or require clarification on maintaining
or operating this product, please contact us for further assistance.
Our contact details are provided below.



Port Causeway, Wirral International Business Park, Bromborough, Wirral, CH62 4TP

 www.paritymedical.com

 +44 (0)151 343 0500

 enquiries@paritymedical.com